

Reflections of a Recovering Bio-Narcissist on the Singularity

Or, Why Elon is Wrong

Trent McConaghy

@trentmc0

Berlin, August 18, 2016

**MY HOUSE GOT BROKEN INTO
AND THEY STOLE ALL MY STUFF**

**BUT I MADE IT TO THE TOP OF R/ALL
YESTERDAY SO I GOT THAT GOING FOR ME
WHICH IS NICE**

**MY HOUSE GOT BROKEN INTO
AND THEY STOLE ALL MY STUFF**



What if this is you?
What if this is all of humanity? How?
What can we do about it?

A bit about me

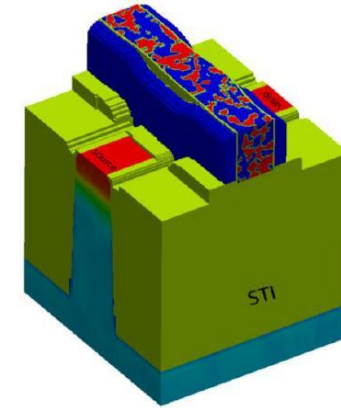
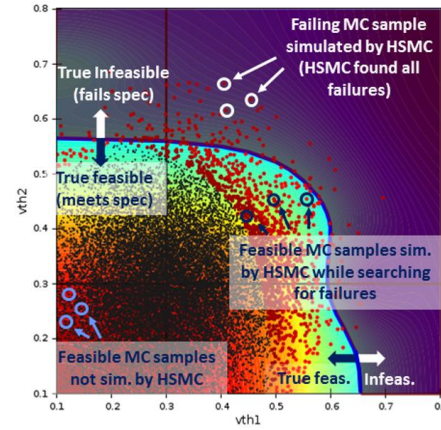
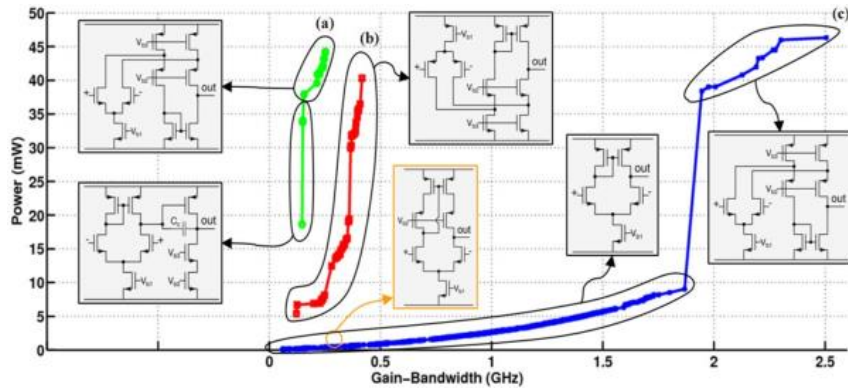

20 years of AI, machine creativity,
Moore's Law, analog circuits, blockchain

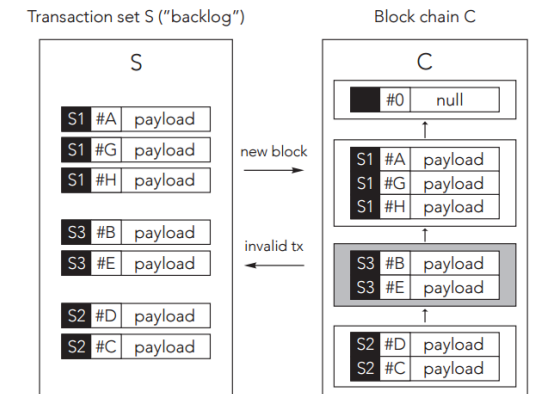
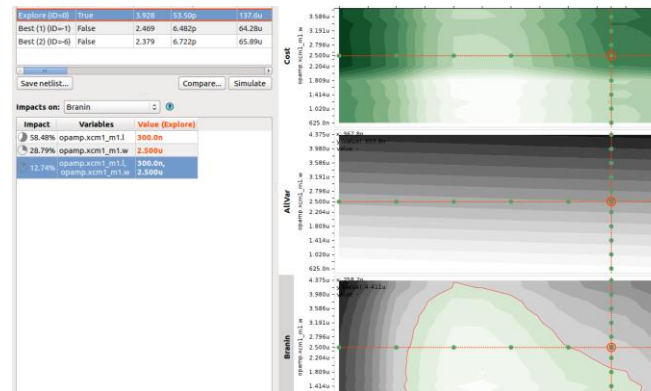
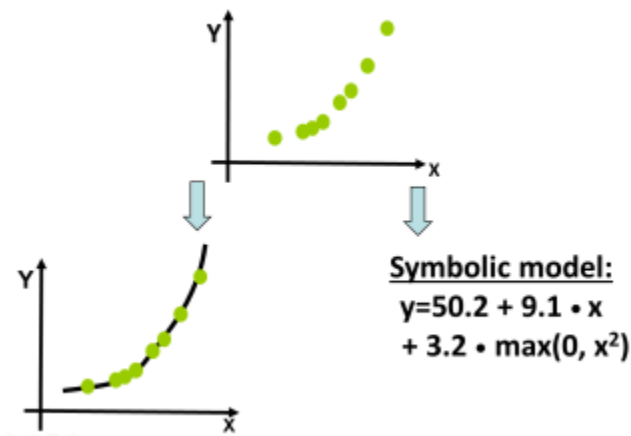

Let's paint a picture



Giving AIs control of our cars



Giving AIs control of our trucks



Giving AIs control of our grid

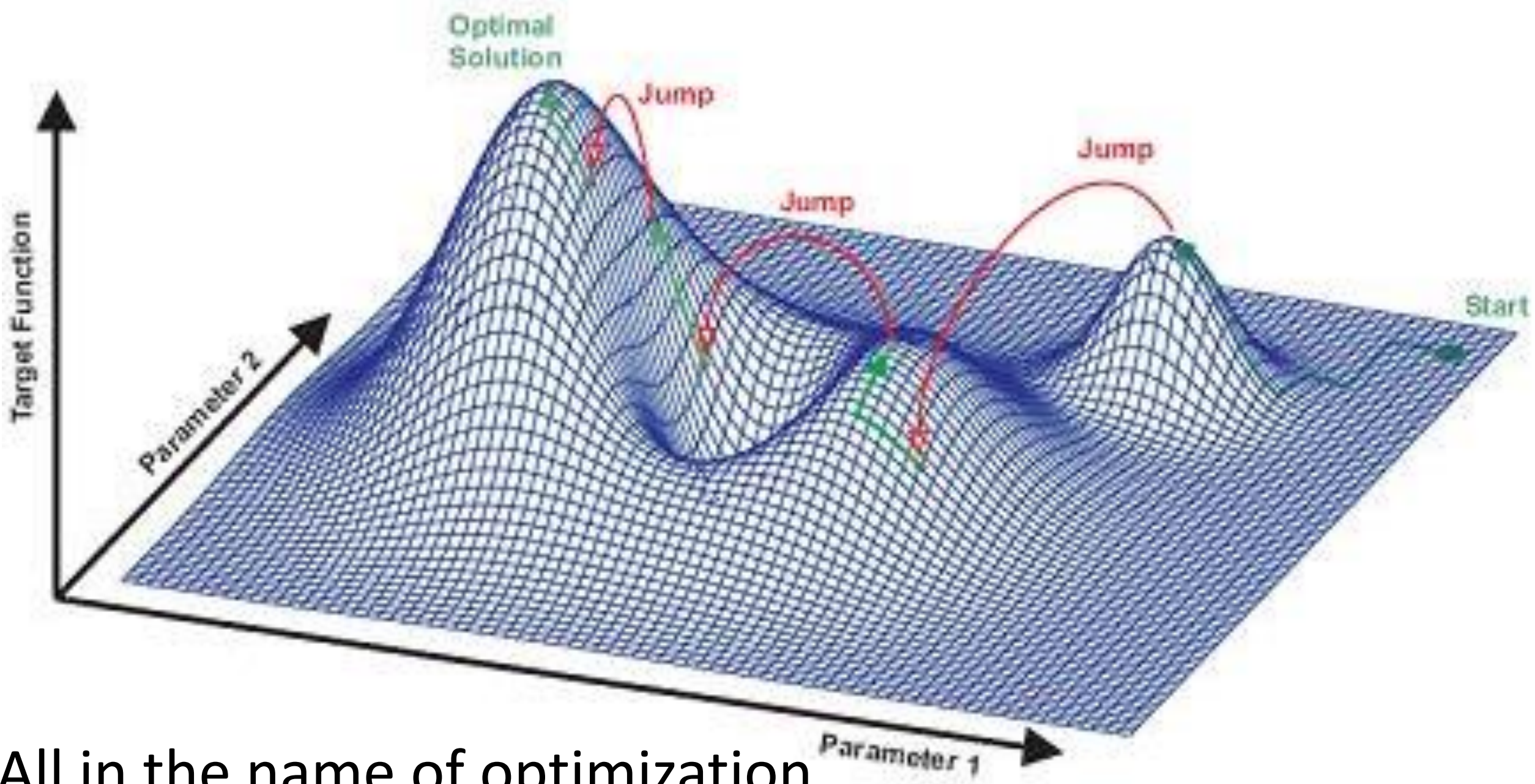

All in the name of optimization

Higher-level integration, higher-level optimization

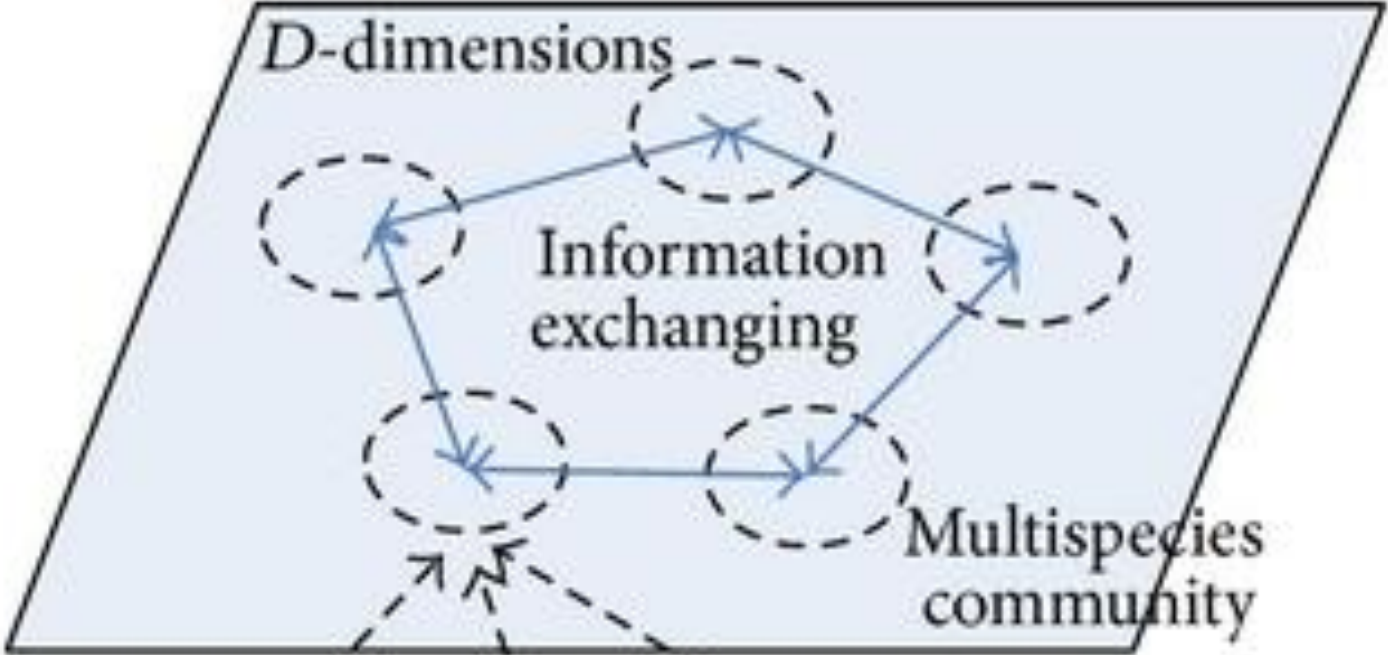

Decentralization at higher levels

DAO = Decentralized Autonomous Organization

DAO: a computational process that

- runs autonomously,
- on decentralized infrastructure,
- with resource manipulation.

It's code that can *own* stuff!

You can't turn it off.

Decentralization at higher levels

DAO: Decentralized Autonomous Organization

DAO: a computational process that

- runs autonomously,
- on decentralized infrastructure,
- with resource manipulation.

It's code that can *own* stuff!

You can't turn it off.

What about AI DAOs? (DAOs with AI-level decision making)

AI DAO Architectures 1, 2: AI at the center, or at the edges

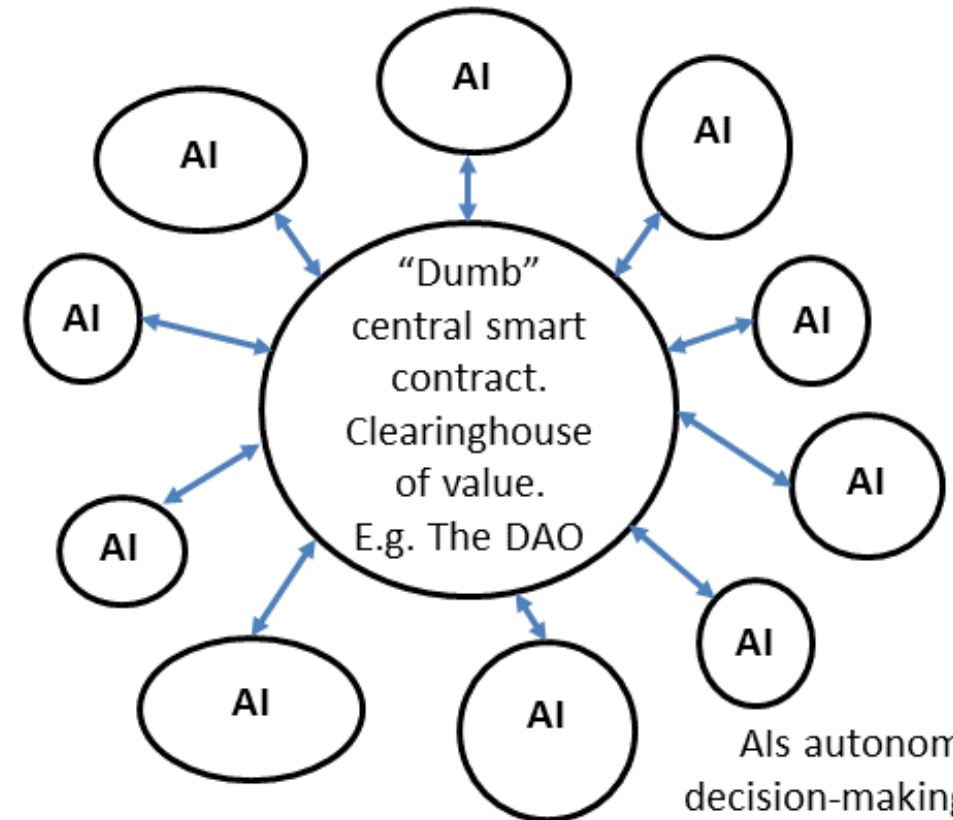
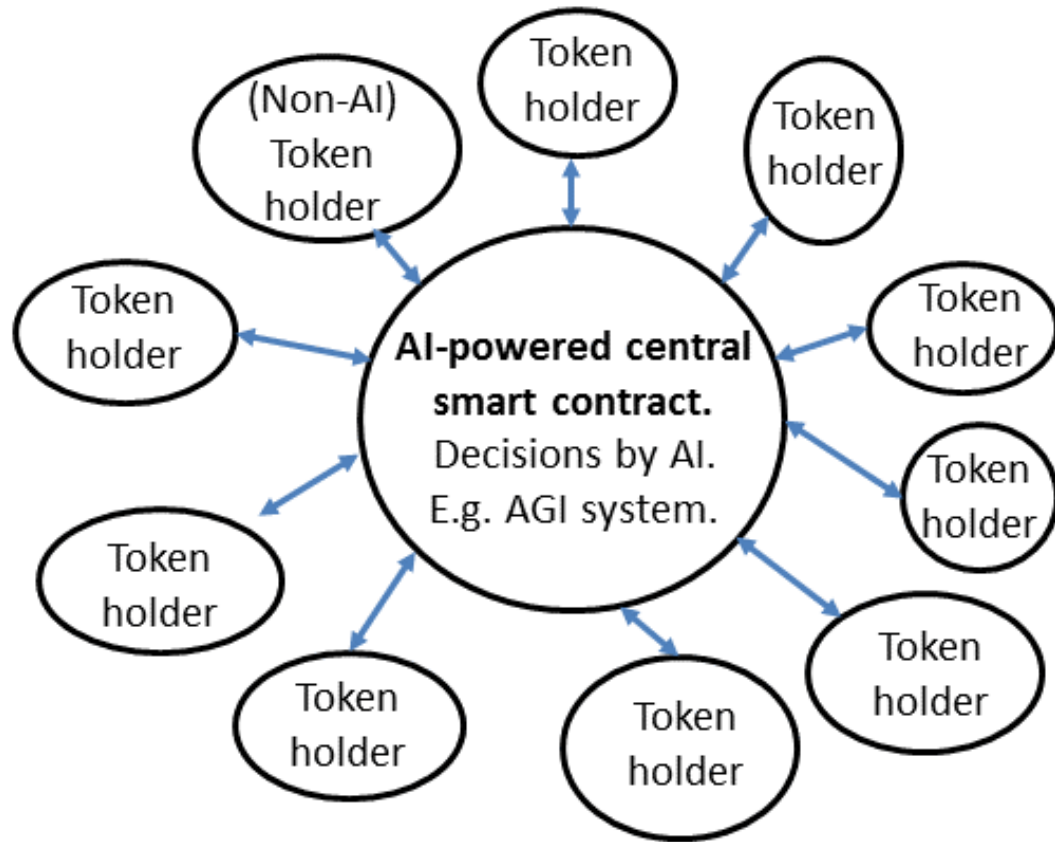

Als autonomously do decision-making. AI may be narrow (e.g. deep nets) or more general (e.g. AGI)

A large flock of birds, likely starlings, flying in a V-shape against a clear sky. The birds are densely packed in the center of the V, with the density decreasing towards the edges. The background is a gradient of light blue and white, suggesting a clear sky.

AI DAO Arch 3:
Swarm Intelligence
Many dumb agents with emergent AI complexity

AIs Become AI DAOs, everywhere

The AIs *own* stuff.
You can't turn them off.
And you've just given them
control of all your resources.

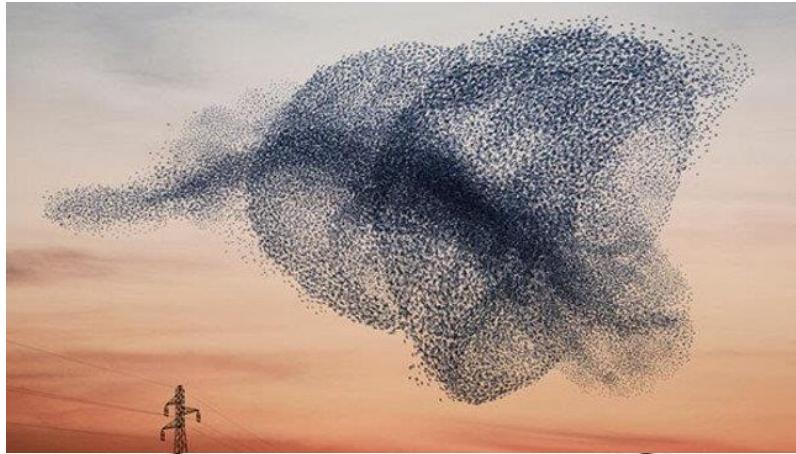

Scenarios Where AIs Could Control All Our Resources

1. We give it to them. (Just covered)
2. They take it from us.

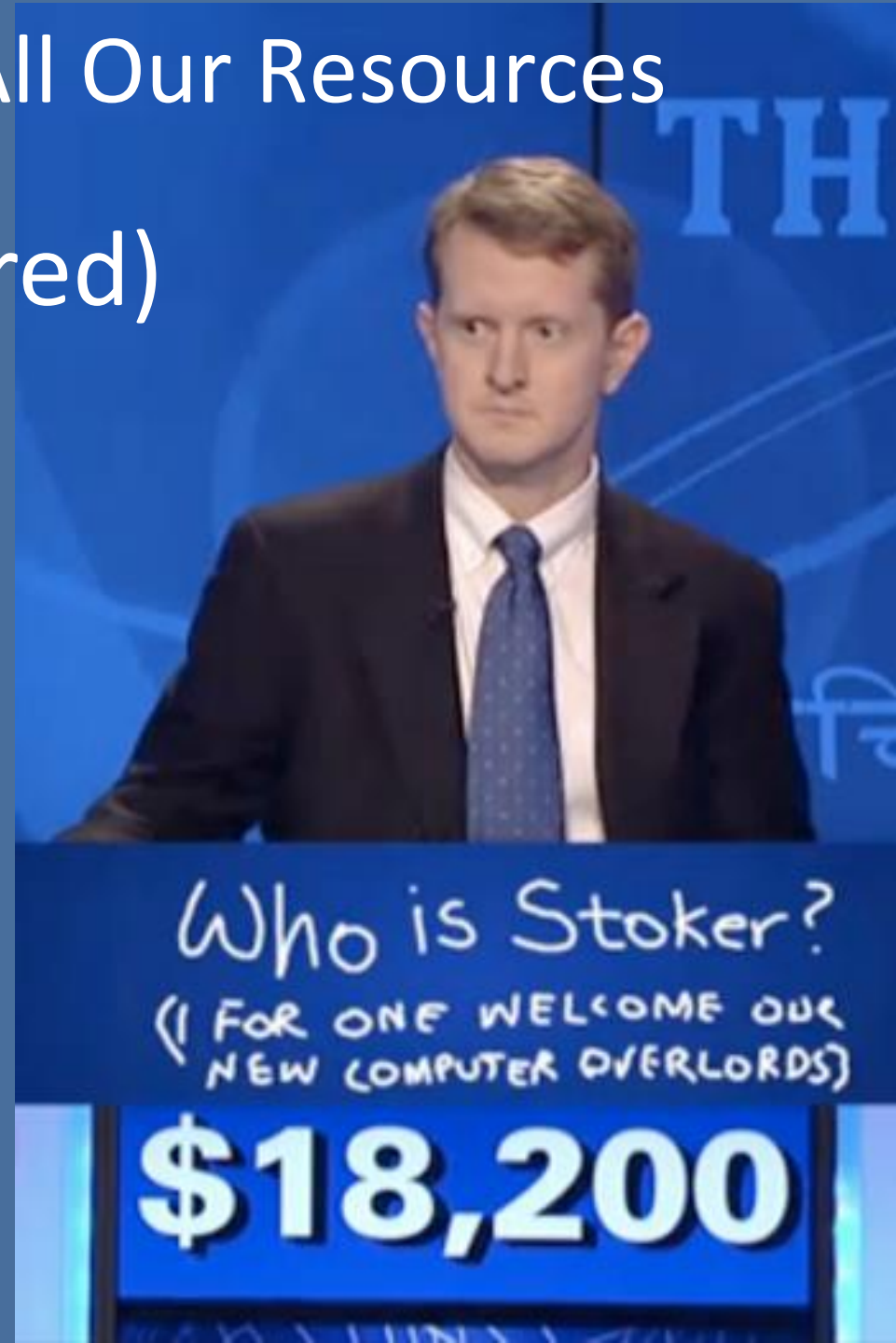

Scenarios Where AIs could control all our resources

1. We give it to them.
2. They take it from us.
 - Could happen if AI “wakes up”
 - Once it’s as smart as us... it will get smarter yet
 - AI waking up is closer than you may realize...



Why AI Waking Up is Closer Than It Appears

1. \$B's going into chips which drive AI

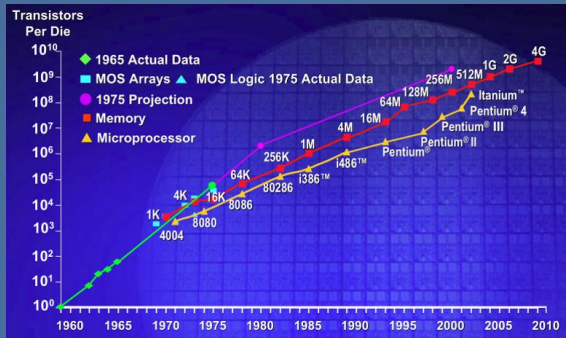

2. \$B's going into AI directly

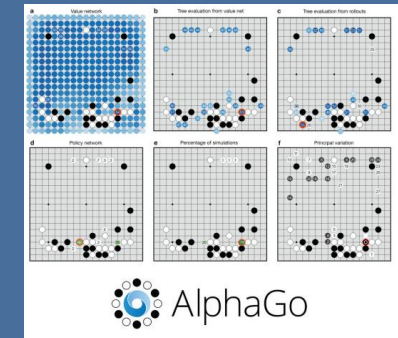

3. DAO infrastructure is coming of age



4. There are no fundamental roadblocks.

Myths: humans are uniquely creative, brain dynamics constrained to human brains

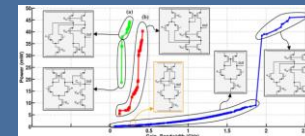

Scenarios Where AIs Could Control All Our Resources

1. We give it to them.
2. They take it from us.

And they just optimized...
you out of the system.

But you've saved some money
Which is nice



How to keep some resources for
our selves?
(aka how do we save humanity?)



Elon:
“We’ll just regulate it”
 (“Safe AI”)



Can ants regulate humans?

How can our neurons possibly compete?

How can our neurons possibly compete?

A: Use a competitive substrate!

Join the machines. Silicon.

Get over your bio meatbag self.

(And call yourself a recovering bio-narcissist.)

WORK, LOVE, AND LIFE
WHEN ROBOTS RULE THE EARTH

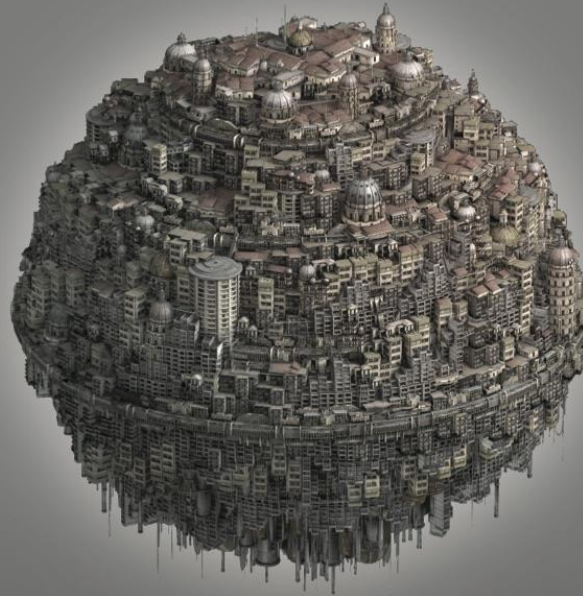

THE
AGE
OF **EM**

ROBIN HANSON

**Option 1:
Uploads.**



Option 2:
Bandwidth++

Brain-computer interfaces



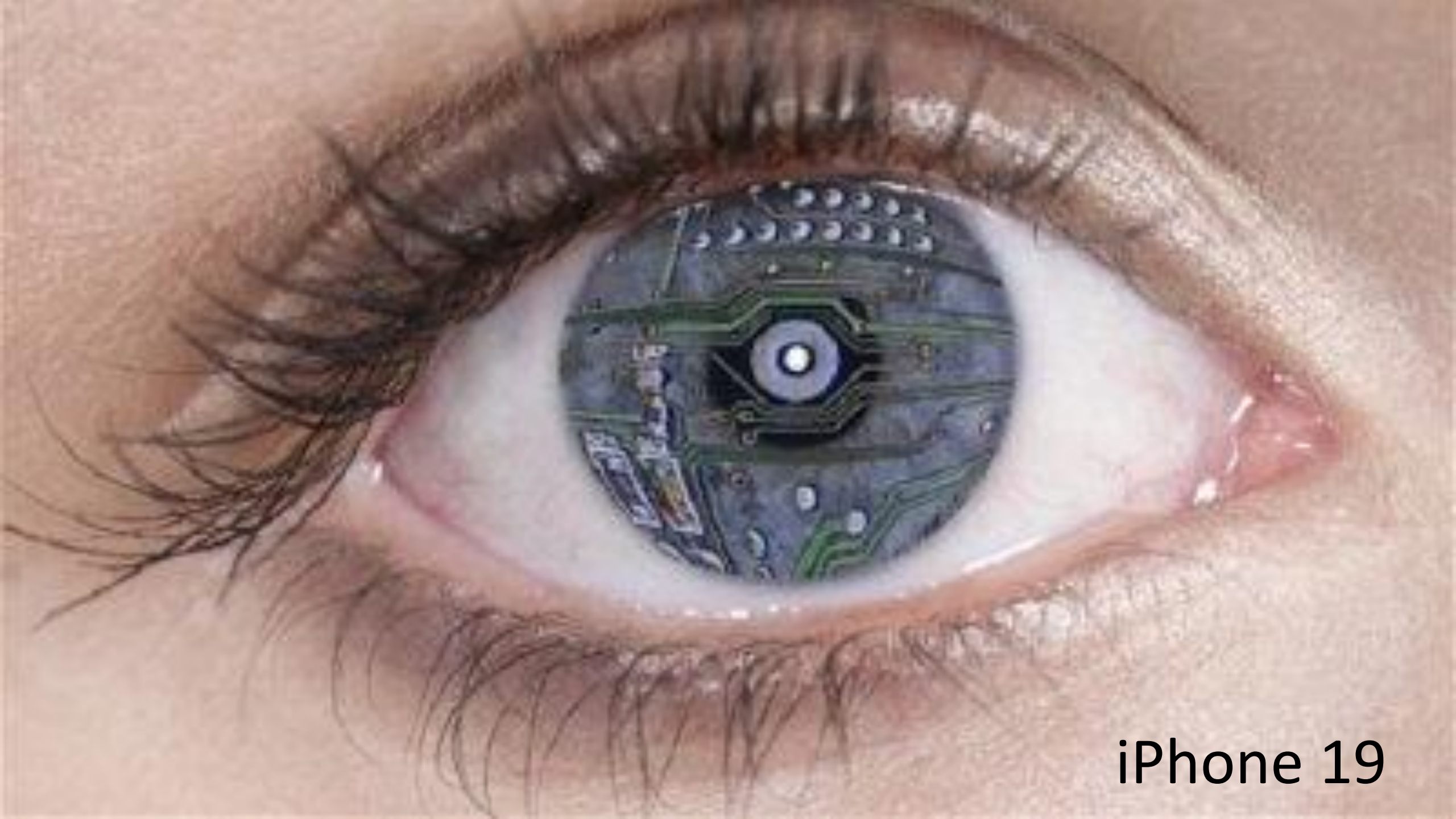

iPhone 19

IT'S A RACE!

IT'S A RACE!

How to win?

\$\$ into the human side

Turn it into a market competition

Summary:

- AIs could end up controlling all our resources
 - Either we give it to them (ooops)
 - Or they wake up and take it
- This is bad. Really bad.
- How to prevent? Ideas..
 - Safe AI / regulations? (Nope)
 - Join the machines. Ems, Bandwidth++
- It's a race!

**MY HOUSE GOT BROKEN INTO
AND THEY STOLE ALL MY STUFF**



Your choice

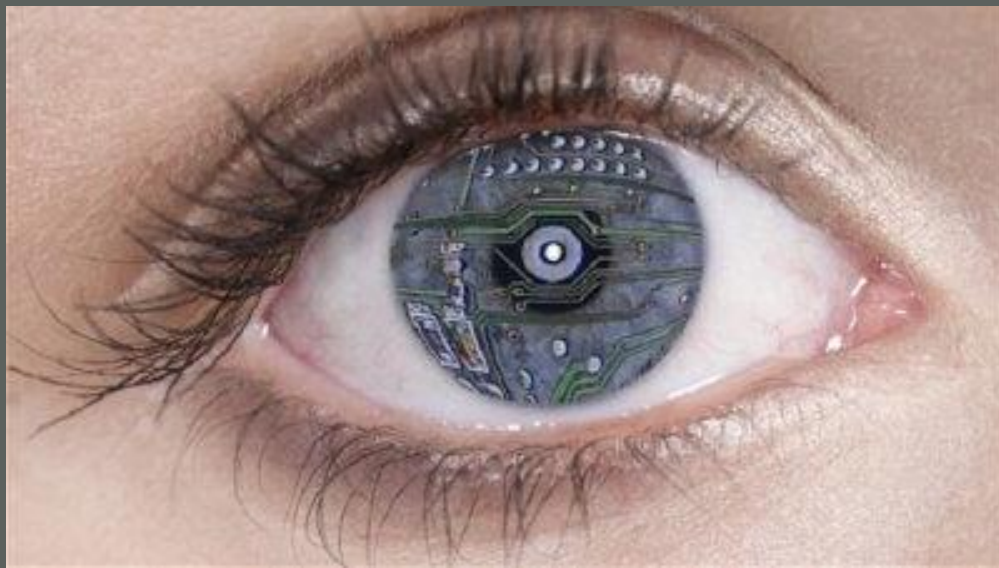

(And
humanity's
choice)

Further reading

- <https://medium.com/@trentmc0/the-ai-existential-threat-and-the-bandwidth-scenario-4573c1cb085f#.8t6sr5tgk>
- And more at <https://medium.com/@trentmc0>,
<http://www.trent.st>